

# **AIBA OPEN BOXING (AOB) COMPETITION RULES**

**Effective as of February 1, 2015**

# TABLE OF CONTENTS

COMPLIANCE TO THE RULES .....	3
DEFINITIONS .....	3
RULES FOR COMPETITION MANAGEMENT .....	5
RULE 1. REGISTRATION OF BOXERS.....	5
RULE 2. MEDICAL EXAMINATION.....	5
RULE 3. WEIGH-IN .....	6
RULE 4. SUBSTITUTION OF BOXERS AT GENERAL WEIGH-IN.....	7
RULE 5. OFFICIAL DRAW.....	7
RULE 6. DURATION AND NUMBER OF ROUNDS .....	8
RULE 7. AOB COMPETITION APPROVAL .....	8
RULE 8. COMPETITION VENUE REQUIREMENTS .....	8
RULE 9. FIELD OF PLAY (FOP).....	9
RULE 10. AIBA ANTI-DOPING REGULATIONS .....	11
RULES FOR COMPETITION OFFICIALS.....	12
RULE 11. SUPERVISOR .....	12
RULE 12. DEPUTY SUPERVISORS.....	13
RULE 13. INTERNATIONAL TECHNICAL OFFICIALS (ITOs).....	14
RULE 14. RINGSIDE DOCTORS .....	15
RULE 15. AIBA CUTMAN .....	17
RULE 16. COMPETITION MANAGER.....	17
RULE 17. REFEREES & JUDGES.....	17
RULES FOR COMPETITION EQUIPMENT .....	19
RULE 18. COMPETITION EQUIPMENT.....	19
RULE 19. GLOVES.....	19
RULE 20. HEADGUARDS.....	19
RULE 21. BANDAGES .....	20
RULE 22. COMPETITION UNIFORM AND PROTECTOR .....	20
APPENDIX A – AOB COMPETITION GUIDELINES .....	21
APPENDIX B – WORLD RANKING GUIDELINES.....	23
APPENDIX C – SEEDING PROCEDURE FOR THE OFFICIAL DRAW (Men and Women).....	26
APPENDIX D – BOXERS’ UNIFORM GUIDELINES .....	32
APPENDIX E – GLOVES AND HEADGUARD SPECIFICATIONS AND GUIDELINES.....	35
APPENDIX F – DECLARATION OF NON-PREGNANCY .....	39
APPENDIX G – USER’S GUIDELINES FOR CAVILON™ CUT PREVENTION .....	41

## COMPLIANCE TO THE RULES

These AOB Competition Rules apply to AIBA Open Boxing and are the only AOB Competition Rules worldwide that AIBA National Member Federations, boxing members, clubs and boxing family must follow and respect in all their boxing competitions in accordance to activities at all levels. No National Federation may develop its own Competition Rules that are contradictory to these AOB Competition Rules. The AIBA Technical Rules also apply to AOB Competitions.

## DEFINITIONS

“**AIBA**” means the International Boxing Association;

“**AIBA Competitions**” means any Boxing Match, Competition, Event, League or Tournament which is authorized and approved in accordance with the AIBA Technical Rules and AIBA 3 Programs Competition Rules (AOB, APB and WSB);

“**AIBA Cutman**” means the person who is appointed by AIBA as one of the ITOs and who is responsible for treating Boxers' cuts only in AOB Competitions.

“**AIBA Official Boxing Equipment Licensee**” means the contracted licensee of AIBA who is approved to produce the official equipment for use at all AOB Competitions;

“**AOB**” means AIBA Open Boxing;

“**AOB Competitions**” means competitions regulated by these AOB Competition Rules including AIBA owned and controlled Confederation Competitions and National Competitions;

“**APB**” means AIBA Pro Boxing;

“**BMA**” means the Boxing Marketing Arm, the exclusive marketing agency for all AIBA commercial properties, managing all properties of AOB, APB and WSB and owned by AIBA and third party investors;

“**Bout**” means the boxing contest between two Boxers taking place as part of a competition;

“**Boxer**” means any athlete registered by an AIBA National Member Federation and a member of AIBA;

“**Coach Certification**” means the permission to act as a Coach in AIBA Competitions granted by any National Federation, after the person passes examinations and obtains a certificate;

“**Competition Official**” means any person appointed or certified to act as a Referee, a Judge, a Supervisor, a Ringside Doctor, an International Technical Official or any assigned position in AIBA Competitions;

“**Confederation**” means each AIBA continental affiliated organization;

“**Continental Multi-Sport Games**” means All-Africa Games, Pan American Games, Asian Games and European Games;

“**Daily Weigh-In**” means the daily process of checking registered Boxers with document check, medical check and weigh-in before their competitions in each day;

“**Delegation**” means participating Team Members including Boxers, Coaches, Doctors and Team Managers in AIBA Competitions;

“**Deputy Supervisors**” means the persons who are assigned by the Supervisor in any AOB Competition and who manage all issues related to each Bout;

“**Disciplinary Code**” means the code governing disciplinary matters applicable to AIBA, each Confederation, each National Federation and any Official, including Competition Official, or Boxer;

**“Draw Commission”** means the group of minimum two persons who will draw Referees & Judges for each Bout in any AOB Competition;

**“Dual Match”** means the competition featuring Boxers from two countries only;

**“Field of Play (FOP)”** means the competition area which extends to 6 meters from all 4 sides of the ring where only Competition Officials can enter;

**“General Weigh-In”** means the required process before the Official Draw in order to conduct document checks, medical-examination and weigh-in of all registered Boxers;

**“Individual Physical Contact Sport”** means any of the following sports in any of its forms: Aikido, Cage Fighting, Judo, Ju-jitsu, Karate, Kendo, Kickboxing, K-1, Muaythai, MMA, Sambo, Savate, Sumo, Taekwondo, Wrestling, Wushu and such other sports as may be deemed by AIBA to be an individual physical contact sport;

**“ITOs”** means the International Technical Officials who are appointed by AIBA, excluding the Referees & Judges and the Supervisor, such as the Deputy Supervisors, the Draw Commission Members, the Ringside Doctors, the Cutman, the R&J Coordinators and the Equipment Managers;

**“Medical Bout Report”** means the form that is filled out by the Ringside Doctor after the Bout to report any medical related activities taken place during the Bout;

**“Medical Handbook”** means the rules published by AIBA in relation to the medical standards required to be observed by a Boxer and by any other Official prior to, during and after AIBA Competitions;

**“National Federation”** means a legal entity recognized by AIBA as the governing body for the sport of boxing in its respective country;

**“National Level Competitions”** means the boxing competitions organized and/or sanctioned by a particular National Federation and to which only Boxers registered from that National Federation participate;

**“Official Draw”** means the ceremony to draw the Boxers to decide the Bout schedules in each Weight Category;

**“Rules”** means the AIBA Technical Rules, AIBA 3 Programs Competition Rules (AOB, APB and WSB), AIBA Code of Ethics, AIBA Disciplinary Code, AIBA Procedural Rules, AIBA Anti-Doping Rules and AIBA Medical Handbook;

**“Seconds”** means the Coaches or Trainers who are certified by AIBA and who are allowed to act in the corner of the ring;

**“Seeding”** means the system to ensure that the competition’s Official Draw may have a better balanced competition schedule in order to maintain attractiveness of the competition;

**“Supervisor”** means the person who is appointed by AIBA to be responsible for all technical and competition related issues in AOB Competitions; A Supervisor may be certified in all AIBA Competitions or only in AOB Competitions;

**“Team Officials”** means the Team Managers, Coaches and Doctors entered by a National Federation in AOB Competitions but does not include the Boxers;

**“WSB”** means the World Series of Boxing as organized and administered by the World Series of Boxing SA which was created and is owned by AIBA.

# RULES FOR COMPETITION MANAGEMENT

## RULE 1. REGISTRATION OF BOXERS

- 1.1. Boxers must comply with Rules 1 and 2 of the AIBA Technical Rules (Classification, Membership and Eligibility) to register for an AOB Competition.
- 1.2. When registering for any AOB Competition, all Boxers and Team Officials must provide a copy of their current passport. No other proof of identity will be accepted.
- 1.3. One Entry per Weight Category
  - 1.3.1. In AOB Competitions such as but not limited to the World Championships, Olympic Games, Continental Championships, Olympic Qualifying Competitions and Confederation Competitions, only one Boxer per Weight Category per country will be allowed to compete.
- 1.4. Submission of the Medical Certificate
  - 1.4.1. For all AOB Competitions (AIBA Controlled) and/or Confederation Continental Championships, a Medical Certificate issued within the previous three (3) months must be submitted to the AIBA Headquarters during the registration period or else the Boxer will not be eligible to participate in the competition.
  - 1.4.2. For all other AOB International Level Competitions, other than AOB (AIBA Controlled) and/or Confederation Continental Championships, the National Federation must submit a copy of a Medical Certificate valid within one year when submitting the entry form.
- 1.5. Rest Period
  - 1.5.1. Boxers must respect a minimum rest period of twelve (12 hours) between two (2) Bouts.

## RULE 2. MEDICAL EXAMINATION

- 2.1. At the time fixed for the Weigh-In, Boxers must be considered as fit to compete and examined by a Doctor before being weighed-in. With a view to ensure a smooth running of the Weigh-In, the Supervisor may decide to begin the Medical Examination at an earlier time. The Chairperson of the Ringside Doctors may select Local or Team Doctors to assist with the duties of the Ringside Doctors only for the Medical Examination.
- 2.2. At the Medical Examination and Weigh-In, an up-to-date Boxer's AIBA Competition Record Book along with an annual Medical Certificate, signed and stamped by a Doctor, with correct information must be presented by the Boxer. This Boxer's AIBA Competition Record Book, in which the requisite entries must be written by the Competition Officials in charge, must be signed and/or stamped by the Secretary General or Executive Director of the Boxer's National Federation. If a Boxer's AIBA Competition Record Book is not presented by the Boxer at the Medical Examination and Weigh-In, this Boxer must not be allowed to compete.
- 2.3. Gender Test may be done for AOB Competitions.
- 2.4. At the document check point before the Medical Examination:
  - 2.4.1. Every Woman Boxer aged 18 (eighteen) or older must sign a Declaration of Non-Pregnancy (see Appendix F) certifying that she is not pregnant at that time.

- 2.4.2. Every Girl Boxer aged under 18 (eighteen) at the start of the relevant competition must provide a Declaration of Non-Pregnancy (see Appendix F) signed by herself and at least one of her parents/legal guardians certifying that she is not pregnant at that time.
- 2.4.3. It will be the responsibility of each National Federation's Team Officials to ensure that Girls Boxers under 18 (eighteen) bring such declaration to the relevant competition.
- 2.4.4. Girls and Women Boxers who fail to sign/provide a Declaration of Non-Pregnancy will not be allowed to participate in the relevant competition.

### **RULE 3. WEIGH-IN**

- 3.1. All entered Boxers must attend the General Weigh-In in the morning of the first competition day, except as described in Rule 3.2.
- 3.2. In AOB Competitions, when the number of entered Boxers exceeds 300 after the final entry deadline is closed, and for the Olympic Games, the General Weigh-In may be organized no more than 24 hours prior to the Medical Examination of the first competition day based on the Supervisor's decision.
- 3.3. In any case, the time from the end of the General Weigh-In to the start of the first Bout must not be less than six (6) hours. The time from the end of the Daily Weigh-In to the start of the first Bout of the remaining competition days must not be less than 3 hours.

The Supervisor reserves the right to relax this condition if unavoidable circumstances occur and after consultation with the Chairperson of the Ringside Doctors.

- 3.4. The Weigh-In must be conducted by Competition Officials authorized by the Supervisor. A Team Official of the National Federation of the Boxer may be present at the Weigh-In; however, and in any circumstance, the Team Official is not allowed to interfere in the process of Weigh-In.
- 3.5. For the General Weigh-In, the registered Boxer's weight must not exceed the maximum of the Boxer's Weight Category nor be below the minimum of the Boxer's Weight Category. The weight registered at the General Weigh-In on the first day decides the Boxer's Weight Category for the entire competition.
- 3.6. At the Daily Weigh-In, only the maximum weight limit will be controlled, not the minimum weight limit. If a Boxer exceeds the maximum weight limit at the Daily Weigh-In, that Boxer will not be allowed to continue the competition according to the AIBA Technical Rules 4.7.2. (Walkover).
- 3.7. A Boxer will be allowed to be present at the official scales only once. There will be a zero tolerance on any overweight than the chosen Weight Category.
- 3.8. Scale - The weight is the one shown on the scale, the body being naked except for a swimming suit or underwear. When necessary, the Boxer may take off the underwear. Electronic scales must be used.
- 3.9. Test scales must be prepared. Test scales used at any competition and official Weigh-In scales have to be of the same manufacture and of the same calibration.
- 3.10. The Weigh-In must be conducted by Competition Officials of the same gender.

## **RULE 4. SUBSTITUTION OF BOXERS AT GENERAL WEIGH-IN**

- 4.1. It is permissible to substitute a Boxer who fails to meet his/her Weight Category at the General Weigh-In. In that case, the Boxer may participate in a lower or higher Weight Category, as long as there is no other Boxer from that National Federation who has already passed the official Weigh-In in that Weight Category.
- 4.2. It is also permissible for a National Federation to substitute one Boxer for another at any time up to the close of the Medical Examination and General Weigh-In if the substitute Boxer has been entered as reserve for that Weight Category or any other Weight Category.
- 4.3. This rule is only applicable for competitions where reserved Boxers are permitted.
- 4.4. All other cases of substitution must be finalized the day before the General Weigh-In.

## **RULE 5. OFFICIAL DRAW**

- 5.1. The Official Draw must take place as soon as possible after the completion of the Medical Examination and General Weigh-In. It must be completed no less than three (3) hours prior to the first Bout on the first competition day.
- 5.2. In the case of Rule 3.1.2., the Official Draw must be held one day before the competition.
- 5.3. If the General Weigh-In is organized the morning prior to the first competition day, at least one Team Official of each participating Delegation must attend the Official Draw.
- 5.4. A Computerized Draw System is to be used in all AOB Competitions, except for the Olympic Games where a manual draw may be conducted. In case the Computerized Draw System is not working, a manual system may be used.
- 5.5. Possible Re-Draw - In any case, until the last Weight Category draw is completed, if there is any mistake or unavoidable circumstance taking place, the Supervisor has the right to order that Weight Category draw to be done again.
- 5.6. Byes - In the case there are more than two Boxers in the series, a sufficient number of byes must be drawn in the first series in order to reduce the number of Boxers in the second series to 2, 4, 8, 16 or 32. Boxers drawing a bye in the first series will box in the second series, but in the order in which they were drawn.
- 5.7. The Supervisor must ensure, where applicable, that no Boxer will box twice in the competition before all other Boxers of the same Weight Category have boxed at least once. In special situations, the Supervisor has the right to relax this rule.
- 5.8. Bout Schedule - At the World Championships, Olympic Games and Continental Championships, the Bout schedule must be arranged in the order of weights so that in each series, the lightest weights will be run off first and thereafter in order of weights up to the heaviest weights in that series followed by the lightest weights in the next series, and so on. In arranging the schedule of the Semi-Finals and Finals of these competitions, the wishes of the Organizing Committee may be accommodated by the Supervisor, as long as the results of the Official Draw are not called into question.
- 5.9. Seeding Procedure – It must respect the Seeding Procedure for the Official Draw (see Appendix C) and be in accordance with the World Ranking Guidelines (see Appendix B).

## **RULE 6. DURATION AND NUMBER OF ROUNDS**

- 6.1. In all AOB Elite Men and Youth Boys Competitions, the Bouts must consist of three (3) rounds of three (3) minutes each.
- 6.2. In all AOB Elite Women and Youth Girls Competitions, the Bouts must consist of four (4) rounds of two (2) minutes each.
- 6.3. In all AOB Junior Boys and Girls Competitions, the Bouts must consist of three (3) rounds of two (2) minutes each.
- 6.4. For all above listed competitions, the rest time between rounds is one (1) minute.

## **RULE 7. AOB COMPETITION APPROVAL**

- 7.1. The conditions for an AOB Competition Approval can be found in the AOB Competition Guidelines (see Appendix A).

## **RULE 8. COMPETITION VENUE REQUIREMENTS**

- 8.1. Required Venue Facilities:
  - 8.1.1. Waiting Lounge for Referees & Judges
  - 8.1.2. Boxers' Locker Rooms
  - 8.1.3. Anti-Doping Rooms
  - 8.1.4. Medical Check Room (Doctor's Room)
  - 8.1.5. Boxers' Warm-Up Area
  - 8.1.6. Storage for Boxing Equipment
  - 8.1.7. Offices for AIBA, Organizing Committee, Supervisor
  - 8.1.8. Media/Press Room, Interview/Press Conference Room, Mixed Zone in accordance with the AIBA Media/Press Guidelines
  - 8.1.9. Meeting Room for ITOs and Referees & Judges
  - 8.1.10. VIP Lounge.
- 8.2. Additional Venue Requirements
  - 8.2.1. The organizers of mixed competitions where both men and women compete must arrange for distinct rooms where the Medical Examination and Weigh-In should be carried out separately for men and women.



## RULE 9. FIELD OF PLAY (FOP)

### 9.1 FOP Set Up – One Ring

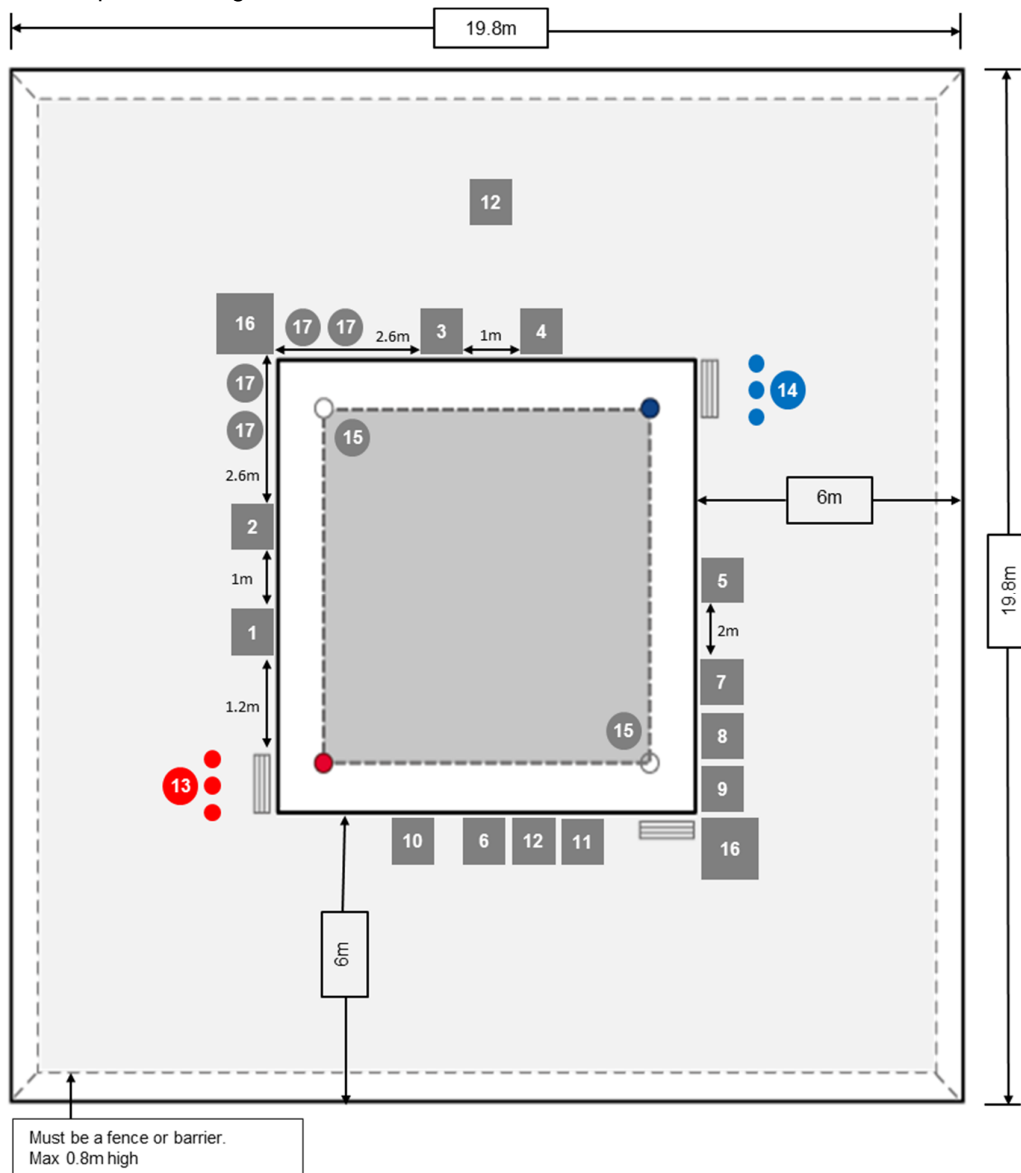

- |    |                     |     |  |
|----|---------------------|-----|--|
| 1: | Judge 1             | 10: | Scoring System Operator/Graphic Operator |
| 2: | Judge 2             | 11: | Ringside Doctor                          |
| 3: | Judge 3             | 12: | AIBA Cutman                              |
| 4: | Judge 4             | 13: | Red Corner Seating Area                  |
| 5: | Judge 5             | 14: | Blue Corner Seating Area                 |
| 6: | Deputy Supervisor   | 15: | Neutral Corner                           |
| 7: | Official Announcer* | 16: | Camera Stands                            |
| 8: | Timekeeper**        | 17: | Photographers                            |
| 9: | Gong Operator**     | 18: | Supervisor                               |
|    |                     | 19: | Draw Commission                          |

The positions of the Draw Commission Table, R&J Coordinator and Standby R&Js will depend of the FOP. The Supervisor will define these positions upon FOP check.

The Graphic Operator can also be placed outside of the FOP.

\* Position 7 (Announcer) can be positioned outside of the FOP.

\*\* Positions 8 (Timekeeper) and 9 (Gong Operator) can be merged into one position.



### 9.3. ITO Positions in and around the FOP

- 9.3.1. The R&J Coordinator must be placed in the same area as the Draw Commission, but, for the avoidance of possible interference, not immediately next to the Draw Commission.
- 9.3.2. The Equipment Managers' table must be located at the Boxers' entrance to the FOP.
- 9.3.3. The Boxers' AIBA Competition Record Book Management must be done at a table located nearby the Boxers' exit from the FOP.

### 9.4. Media Guidelines

- 9.4.1. If a platform for TV cameras is required during a competition, its length and width must each be of 1 meter. Its height will be determined jointly by the TV production organization and the Competition Manager, subject to the Supervisor's approval.
- 9.4.2. The TV camera operators are only allowed to move around the ring's apron during breaks between rounds and between Bouts.
- 9.4.3. Each camera operator may have one assistant at the maximum, and this assistant must remain on the floor.
- 9.4.4. No more than four (4) photographers may be positioned at ringside during competition. They are to remain in a marked area of 1.5 meters from the neutral corner towards Judge 2 and Judge 3.
- 9.4.5. Only at the end of a Bout are photographers allowed to move around the ring, with the exception of the side where the Supervisor is located.
- 9.4.6. Microphones may only be attached to the backside of the pads in the neutral corners.

## **RULE 10. AIBA ANTI-DOPING REGULATIONS**

- 10.1. All issues related to anti-doping are to be found in the AIBA Anti-Doping Rules.
- 10.2. In all Confederation Competitions, anti-doping tests must be conducted.
- 10.3. All records of anti-doping tests, including anti-doping test forms, must be sent to the AIBA Headquarters within twenty four (24) hours after the end of a competition.

# RULES FOR COMPETITION OFFICIALS

## RULE 11. SUPERVISOR

### 11.1. Qualifications

- 11.1.1. The Supervisor must exhibit superior leadership and management skills by having passed the AIBA Supervisor examination or the AOB Supervisor examination and obtained the certification.
- 11.1.2. Active Coaches, Referees, Judges, Team Managers and any person who was ever sanctioned with an over six (6) month suspension cannot be appointed as Supervisor.

### 11.2. Nomination & Appointment

- 11.2.1. For all AOB Competitions categorized as AIBA 3-Star Competitions according to Appendix A, the AIBA Technical & Rules Commission proposes the candidate to the AIBA Headquarters and the AIBA President approves, appoints and dismisses the Supervisor.
- 11.2.2. The Supervisor may not be a national of the country where the competition takes place.
- 11.2.3. For all AIBA 3-Star Competitions, the Supervisor may not be of the same continent as where the competition takes place.
- 11.2.4. For all AOB Competitions categorized as AIBA 2-Star and 1-Star Competitions according to Appendix A, the Confederation Competition Commission proposes the candidate and the Confederation President approves, appoints and dismisses the Supervisor.

### 11.3. Supervisor's Classification and Certification

- 11.3.1. AIBA has two levels of Supervisor's classification: AIBA Supervisor (can be appointed for any AIBA Competition) and AOB Supervisor (can only be appointed for AOB Competitions). A Supervisor certification is proven by an official AIBA certificate and inclusion in the Supervisor Database.

### 11.4. Eligibility

- 11.4.1. Individuals are not eligible to become Supervisors if they are:
  - a. AIBA Certified Referees & Judges
  - b. Active Boxers
  - c. Having any connection to Professional Boxing (except APB) or with any Individual Physical Contact Sport

### 11.5. Supervisor's Test Procedure

- 11.5.1. Supervisor's examinations consist of attending a special workshop and pass a written test. A Supervisor's examination can be taken no more than two times per year and no more than three times per each four-year Olympic cycle.
- 11.5.2. Supervisor's Examiners must have an AIBA Supervisor certification.

## 11.6. Supervisor's Performance Management and Evaluation

11.6.1 In AOB Competitions, the Supervisor will evaluate ITOs based on the criteria developed by the AIBA Technical & Rules Commission and the AIBA Headquarters.

11.6.2 The Supervisor must submit the evaluation results to the AIBA Headquarters who will communicate these results to the AIBA Technical & Rules Commission Chairperson and discuss them on a regular basis.

## 11.7. Decision Making Procedure

11.7.1. The Supervisor will be responsible for all decisions.

11.7.2. The Supervisor must make the Official Announcer aware of the name of the Boxer shown as the winner on the computer monitor after the Bout is over.

11.7.3. The Supervisor must watch the scores and performances of the Referees & Judges and immediately suspend any wrongdoing Referee and/or Judge for the rest of the competition day. Then, once the competition is completed, the Supervisor must discuss any further recommendation to the Disciplinary Commission regarding sanctioning the Referee and/or Judge.

11.7.4. If a Competition Official appointed for a Bout is absent, the Supervisor may appoint a suitable member from the roll of approved Competition Officials to replace the absent member.

11.7.5. If circumstances arise which would affect the holding of a Bout under proper conditions and if the Referee does not take efficient action concerning the situation, the Supervisor may order boxing to cease until it may be satisfactorily resumed.

11.7.6. The Supervisor may also take any immediate action as may be deemed necessary to deal with circumstances that would affect the proper conduct of boxing at any session.

11.7.7. If a Boxer is guilty of a serious and deliberate offence that is contrary to the spirit of sportsmanship, the Supervisor, the Referee and ITOs have the right to recommend to the Executive Committee Bureau to put the case to the Disciplinary Commission for possible sanctions.

11.7.8. The Supervisor may not act as such in Bouts involving Boxers from his/her own country.

11.7.9. The Supervisor will be responsible for cautioning, warning and/or removing Seconds.

## 11.8. Duties

11.8.1. The detailed duties of the Supervisor are listed in the AIBA Technical Officials' Management Guidelines.

## **RULE 12. DEPUTY SUPERVISORS**

### 12.1. Appointment

12.1.1. AIBA will appoint a minimum of two (2) Deputy Supervisors for any AOB Competition that uses two (2) rings.

12.1.2. AIBA will appoint a minimum of one (1) Deputy Supervisor for any AOB Competition that uses one (1) ring.

## 12.2. Qualifications

12.2.1. The Deputy Supervisor must exhibit superior leadership and management skills by having passed the AIBA Supervisor examination and/or the AOB Supervisor examination and obtained the certification. The Deputy Supervisor will be responsible for all competition aspects of the Bout with the same duties as the Supervisor.

12.2.2. Active Coaches, Referees, Judges, Team Managers and any person who was ever sanctioned with an over six (6) month suspension cannot be appointed as Deputy Supervisor.

12.2.3. The Deputy Supervisor may not be a national of the country where the competition takes place and must be from a different nationality than the Supervisor.

## 12.3. Decision Making Procedure

12.3.1. The Deputy Supervisor may not act as such in Bouts involving Boxers from his/her own country.

## 12.4. Duties

12.4.1. The detailed duties of the Deputy Supervisors are listed in the AIBA Technical Officials' Management Guidelines.

# **RULE 13. INTERNATIONAL TECHNICAL OFFICIALS (ITOs)**

## 13.1. Qualifications

13.1.1 Each ITO must obtain the AIBA ITO certification.

13.1.2 Active Coaches, Referees, Judges, Team Managers and any person who was ever sanctioned with an over six (6) month suspension cannot be appointed as an ITO.

13.2. Definition - All Competition Officials working within the Field of Play (FOP) excluding the Supervisor, the Referees & Judges, the Organizing Committee and the AIBA Headquarters staff are called ITOs. ITOs consist of the following persons:

13.2.1. Deputy Supervisors

13.2.2. Draw Commission Members

13.2.3. Ringside Doctors

13.2.4. AIBA Cutman

13.2.5. R&J Coordinators

13.2.6. Equipment Managers

13.3. For all AOB Competitions, the Supervisor nominates the candidates and the AIBA President approves, appoints and dismisses the ITOs.

13.4. For all Continental Championships, the Supervisor nominates the candidates and the Confederation President approves, appoints and dismisses the ITOs.

- 13.5. ITOs may not be more than two from the same nationality in the same competition but these ITOs from the same nationality cannot be assigned in the same Bout.
- 13.6. ITO Certification
  - 13.6.1. An ITO certification is proven by an official AIBA certificate and inclusion in the ITO Database.
- 13.7. ITO Test Procedure
  - 13.7.1. All ITO examinations consist of attending a special workshop and pass a written test. An ITO examination can be taken no more than two times per year and no more than three times per each four-year Olympic cycle.
  - 13.7.2. ITO Examiners must have an AIBA Supervisor certification.
- 13.8. All ITOs must respect and sign the AIBA Code of Conduct which is part of the AIBA Technical Rules.

## **RULE 14. RINGSIDE DOCTORS**

- 14.1. Qualification
  - 14.1.1. For all AOB Competitions, Olympic Games and Olympic Qualifying Competitions, only AIBA Medical Commission Members and AIBA Certified Ringside Doctors are permitted to serve as Ringside Doctors. For all Confederation Competitions, only AIBA and Confederation Medical Commission Members as well as AIBA Certified Ringside Doctors are permitted to serve as Ringside Doctors.
  - 14.1.2. In emergency situations, the Supervisor may appoint Local or Team Doctors in the case of non-availability of Ringside Doctors.
- 14.2. Attendance in Competition
  - 14.2.1. Ringside Doctors must be in attendance throughout the competition and may not leave before the end of the last Bout and until they have seen the two Boxers who participated in such Bout. Ringside Doctors may wear surgical gloves during the Bout.
- 14.3. Number of Ringside Doctors
  - 14.3.1. In the case of one ring, in all AOB Competitions including the World Championships and the Olympic Games, a minimum of three (3) AIBA Ringside Doctors will be appointed. However, there must not be more than two (2) Ringside Doctors at one ringside.
  - 14.3.2. In the case of two rings, in all AOB Competitions including the World Championships, a minimum of five (5) Ringside Doctors will be appointed. However, there must not be more than two (2) Ringside Doctors at one ringside.
- 14.4. Requirement for Anti-Doping
  - 14.4.1. For any AOB Competition, one (1) anti-doping specialist must be present to control the anti-doping process under the supervision of Ringside Doctors.
- 14.5. Main Duties
  - 14.5.1. General Duties

14.5.1.1. Ringside Doctors are designated for all Medical Examinations to ensure that:

- The Boxers have enough space;
- There is a direct access to the Weigh-In room;
- There exists some heating (if necessary), sufficient light and adequate ventilation;
- There is a sufficient number of chairs and tables.

14.5.1.2. At all international competitions, an AIBA Medical Commission Member must be present at the initial Medical Examination and all subsequent Pre-Bout Medical Examinations of the Boxers.

14.5.1.3. Ringside Doctors will assist Doctors from individual countries.

14.5.1.4. Ringside Doctors may express their opinion on injuries that Boxers have sustained and this opinion must be given when invited to do so by the Referee. This opinion will be considered as final.

14.5.1.5. Ringside Doctors must provide a dedicated Doctor to oversee the anti-doping procedures and inspect the designated anti-doping areas to determine adequacy in location, equipment, provisions and forms.

14.5.1.6. Ringside Doctors must carry out the Medical Examination for Referees & Judges;

14.5.1.7. Ringside Doctors must review the emergency plans of the Organizing Committee:

- Check for the presence of oxygen and stretcher, other recovery equipment, evacuation equipment, route of evacuation;
- Check that an ambulance is present for the competition and a hospital designated to take care of stricken Boxers.

14.5.1.8. Ringside Doctors must check that adequate food and hydration provisions are provided to the Boxers and recommended to the Supervisor for approval.

#### 14.5.2. Competition Duties

14.5.2.1. At least one Ringside Doctor must be at ringside for the entire duration of the Bout;

14.5.2.2. Ringside Doctors will direct the Referee in evaluating injuries;

14.5.2.3. Ringside Doctors must inform the Supervisor to stop the Bout in the case any Boxer appears unable to continue.

#### 14.6. Procedure after KO or TKO

14.6.1. Unconscious Boxer - If a Boxer is rendered unconscious, then only the Referee and the Ringside Doctor can remain in the ring, unless the Ringside Doctor needs additional help. In case a Boxer is unconscious for more than one (1) minute, this Boxer must be transported to the nearest hospital (if possible to the neurosurgery department) for further evaluation. Any Boxer with a concussion may be referred to the hospital by the Ringside Doctor.



- 14.6.2. Medical Attention - In the case of a Knockout without unconsciousness or in the case of Technical Knockout, the Boxer must be examined by a Doctor immediately afterwards in the locker room to determine the nature of the injury and the need of a further medical observation and/or hospitalization.
- 14.6.3. Ringside Doctors may recommend treatment for injured Boxers.
- 14.6.4. Ringside Doctors may suspend and restrict injured Boxers as they feel appropriate.
- 14.6.5. Ringside Doctors must fill out the Medical Bout Report in the case a restriction period and/or protective sanitary measures have been ordered for the Boxer.

## **RULE 15. AIBA CUTMAN**

- 15.1. When a Boxer suffers from a cut during a Bout, and when deemed necessary by the Ringside Doctor, he/she may ask the AIBA Cutman to treat this cut.
- 15.2. The Deputy Supervisor may stop a Bout, only one time, for up to forty-five (45) seconds for the Cutman to treat the cut;

## **RULE 16. COMPETITION MANAGER**

- 16.1. The Competition Manager must be nominated by the Host National Federation and approved by the AIBA or the Confederation depending if it is an AOB Competition or a Confederation Competition.
- 16.2. The Competition Manager is responsible for following the instructions and guidelines of the Supervisor and perform the duties that are described in the AIBA Technical Officials' Management Guidelines.
- 16.3. The Competition Manager must have an excellent level of spoken English.

## **RULE 17. REFEREES & JUDGES**

- 17.1. Appointment and Neutrality
- 17.1.1. To ensure neutrality, the names of the Referee and of the Judges for each Bout will be selected by a Computerized Software Program and/or by the Draw Commission.
- 17.1.2. Each of such Referee & Judge must be an approved Referee & Judge.
- 17.1.3. Each of such Referee & Judge must be of a different country and National Federation from one another as well as from any of the Boxers taking part in the Bout.
- 17.1.4. Each of such Referee & Judge must not be a national or resident in any country which is a dominion, colony or dependency of the country of any of the Boxers taking part in the Bout.
- 17.1.5. In the case of a change of nationality, such Referee & Judge must not officiate in any Bout in which a Boxer of the Referee & Judge's former nationality is taking part.
- 17.1.6. In the case the Draw Commission cannot apply the above directives, the difficulty must be resolved by ensuring as far as it may be possible the neutrality and impartiality of the Officials appointed, and the matter must be reported as soon as convenient to the Supervisor.

17.1.7. In the case it is impossible for the Draw Commission to comply with the above directives, the Supervisor must make the final selection.

17.2. Conflict of Interest

17.2.1. Referees & Judges in any Bout must not at any time during the same Bout act as Team Manager, Coach or Second to any Boxer taking part in such Bout or so act in a Bout in which a Boxer of their nationality is taking part.

17.3. Disciplinary Action

17.3.1. A decision on suspension related to Referees' or Judges' poor performances in a competition will be made by the Supervisor.

17.3.2. A decision of suspension related to Referees' or Judges' ethics must be made by the Disciplinary Commission.

17.4. Code of Conduct

17.4.1. All Referees & Judges must respect and sign the AIBA Code of Conduct which is part of the AIBA Technical Rules.

# RULES FOR COMPETITION EQUIPMENT

## RULE 18. COMPETITION EQUIPMENT

18.1 In all AOB 3-Star Competitions, WSB Competitions and APB Competitions, gloves, headguards and bandages manufactured by one of the AIBA Official Boxing Equipment Licensees shall be provided by AIBA via the Organizing Committee and shall be approved by the Supervisor.

## RULE 19. GLOVES

19.1 Boxers must wear red or blue gloves, as per the respective Boxer's corner.

19.2 Boxers must put on their gloves before entering the ring.

19.3 Gloves must be taken off immediately after the Bout is over and before the decision is announced.

19.4 The padding of the gloves must not be displaced or broken.

19.5 Only clean and serviceable gloves must be used.

19.5.1 All Gloves must be cleaned using 10% Sodium Hypochlorite before they are used again.

19.5.2 For all AOB Competitions except Elite Men, ten (10) oz gloves must be used.

19.5.3 Detailed specifications on gloves can be found in Glove Specifications and Guidelines (see Appendix E).

## RULE 20. HEADGUARDS

20.1. In AOB Elite Men Competitions, headguards are not allowed at all National, Continental and International Levels. For all other category competitions, headguards are still mandatory. However, AIBA reserves itself the right to conduct some non-Elite Men Competitions without headguards for the preparation of the definitive removal of headguards for all categories starting from January 1, 2018.

20.1.1. For all Boxers not wearing headguards and in order to prevent any potential cut, Coaches are permitted to apply the cut prevention material Cavilon™ on all areas of the Boxer's face before all competitions held without headguards. Detailed User's Guidelines are attached in Appendix G.

20.2 Boxers must wear a red or blue headguard, as per the respective Boxer's corner.

20.3 Boxers must put on their headguards only after entering the ring.

20.4 Headguards must be taken off immediately after the Bout is over and before the decision is announced.

20.4.1 All headguards must be cleaned using 10% Sodium Hypochlorite before they are used again.

## **RULE 21. BANDAGES**

### 21.1. Use of Bandages

21.1.1. Bandages must be applied in the locker room in the presence of a Host National Federation Official. The bandages of each Boxer must be checked and marked by the Equipment Manager at the equipment check table.

### 21.2. Specifications

21.2.1. Bandages must not be longer than 4.5m (14.76 feet), and not shorter than 2.5m (8.2 feet). Bandages must be 5.7cm (2 ¼ inches) wide.

21.2.2. Bandages must be made of stretchy cotton material with a Velcro closure.

## **RULE 22. COMPETITION UNIFORM AND PROTECTOR**

22.1. Boxers must box in light boots or shoes (without spikes or heels), socks (not to be worn higher than knee length).

22.2. The length of the shorts must not be shorter than mid-thigh, cannot cover the knee and must not be worn above the belt line. The belt line is an imaginary line from the navel to the top of the hips and must not cover the navel.

22.3. Boxers must wear a set of red or blue vest and shorts according to their respective corner allocation. Either skirts or shorts can be worn by women or girl boxers. The uniform colors must be one of the following:

Red: Pantone 185, 199 or 485

Blue: Pantone 286, 293 or 661

22.4. The belt line of any shorts or skirt must be white and 6-10cm wide (the belt line is an imaginary line from the navel to the top of the hips).

22.5. Boxers will not be allowed to have tape, in any form, on their uniform.

22.6. For all Women competitions, a breast protector and a pubic protector may be worn by the Boxers.

22.6.1. Women's breast protectors may not shield any target area of the body, including the breastbone. Protectors must have no metal parts except if there is a fastening site at the back of the Boxer.

22.7. Referees & Judges must wear only the official AIBA attire for Referees & Judges.

22.8. Referees may use surgical gloves when officiating.

22.9. Detailed specifications on uniforms can be found in Boxers' Uniform Guidelines (see Appendix D).

## APPENDIX A – AOB COMPETITION GUIDELINES

### 1. AOB Competitions

- 1.1. In each year, AIBA will set the maximum number of AOB Competitions to be held in any one calendar year at its Executive Committee meeting.
- 1.2. An AOB Competition may not be staged on the same day as another one, unless the two competitions are in different countries and do not share a common border.
- 1.3. In principle, no more than one (1) AOB Competition may be staged in the same city in any one year.
- 1.4. A maximum of three (3) AOB Competitions can be staged in the same country depending on their consistent excellence and their tradition.
- 1.5. AIBA will only consider applications for AIBA Status from those countries that have previously held an International Tournament on a regular basis and which are approved by the National Federation.
- 1.6. Applications for AIBA Status must be submitted to the AIBA Headquarters by National Federations by September of the year preceding the competition.
- 1.7. Any National Federation applying for the upgrade of a competition must submit the application along with the results of all previous tournaments and reasons for the upgrade request.
- 1.8. Any National Federation applying for any AOB Competition will need to fulfill AIBA's requirements such as budget, hosting fee, full compliance with the AIBA Technical Rules and these AOB Competition Rules, Anti-Doping Code, TV coverage. The level of requirements will depend on the status of the competition.
- 1.9. AOB Competitions are divided into three (3) levels (1-Star, 2-Star and 3-Star Competitions) depending on the number of Boxers participating from different countries and the level of the Boxers (World Ranked Boxers):
  - 1.9.1. AOB 3-Star Competitions – AIBA International Tournaments
    - 1.9.1.1. All following AOB Competitions are controlled and managed by AIBA, and the rights belong to AIBA:
      - World Championships (Men and Women)
      - Youth World Championships (Men and Women)
      - Junior World Championships (Boys and Girls)
      - All Qualifying Competitions for the Olympic Games and Youth Olympic Games
    - 1.9.1.2. World Championships System for Elite Men:
      - 1.9.1.2.1. For the year before the Olympic Games (2015, 2019, 2023 and so on):
        - The World Championships will be held only with Boxers who qualified through all Continental Championships.
      - 1.9.1.2.2. For the year of 2017, 2021, 2025 and so on:
        - The World Championships will be held with all Boxers registered by any National Federation
    - 1.9.1.3. International and Confederation Competitions with the participation of more than 20 countries and over 150 Boxers.
    - 1.9.1.4. Continental Confederation Qualification Championships for Men
    - 1.9.1.5. Continental Multi-Sport Games, such as Olympic Games, Asian Games, All-Africa Games, European Games and Pan American Games.

1.9.2. AOB 2-Star Competitions – AIBA Confederation Competitions:

1.9.2.1. International and Confederation Competitions with the participation of between 13 – 19 countries and over 100 Boxers.

1.9.2.2. Continental Confederation Qualification Championships for Women

1.9.3. AOB 1-Star Competitions – AIBA Regional Competitions:

1.9.3.1. International and Confederation Competitions with a participation of between 3 – 12 countries.

## 2. Approval Procedure

### 2.1. National Level Competitions:

2.1.1. For National Level Competitions, the following order procedure needs to be respected:

2.1.1.1. National Federation's approval is mandatory

2.1.1.2. Confederation's approval is mandatory

2.1.1.3. AIBA's approval may be requested

2.1.2. All other competitions may be AOB Competitions or not, which is something the Host National Federation has the liberty to choose. However, even in the case of non-recognized AOB Competitions, the AIBA Technical Rules and these AOB Competition Rules must apply anyway.

2.1.3. An approval must be obtained no later than three (3) months before the competition starts.

2.1.4. This procedure may be implemented for any Championships, Dual Match, Invitation (team or individual) or all other Regional Competitions.

### 2.2. Confederation Competitions:

2.2.1. For Continental Level Competitions, the approval needs to be given by the Confederation and/or by AIBA.

2.2.2. This can be done for Continental Championships, Confederation Competitions and International Multi-Confederation Competitions.

## 3. Confederation Competitions

### 3.1. The Confederation Competitions classified as Category A are:

- Men's Continental Championships
- Women's Continental Championships
- Youth Continental Championships
- Women's Youth/Junior Continental Championships
- Junior Continental Championships
- All AOB 3-Star Competitions

### 3.2. The Confederation Competitions classified as Category B are:

- Men's and Women's Confederation Union Championships
- Schoolboy and Schoolgirl Confederation Championships
- All Confederation Competitions which are below the 3-Star competitions standard above mentioned and with a participation of at least 5 countries and at least 50 Boxers.

## APPENDIX B – WORLD RANKING GUIDELINES

### 1. World Ranking Point Allocation (Men and Women)

- 1.1. The World Ranking points for each Boxer are accumulated over a two (2) year “rolling” period.
- 1.2. The World Ranking points will be awarded for each competition and maintained in full for four (4) competitions.
- 1.3. From the 5<sup>th</sup> competition onwards (up to a maximum of 7 competitions), any World Ranking point awarded will be decreased by 25% per competition.
- 1.4. The Official AIBA World Ranking is issued after each competition counting into the ranking system.
- 1.5. Every Boxer participating in a 3-Star Competition as listed in Appendix A, except in all Qualifying Competitions for the Olympic Games and the Youth Olympic Games, will be ranked within the competition and will gain points depending on final result and position.
- 1.6. For Men, World Ranking points will be allocated for the following the listed competitions:
  - Olympic Games
  - World Championships
  - Continental Multi-Sport Games
    - All-Africa Games
    - Asian Games
    - European Games
    - Pan American Games
  - Confederation Championships

Ranking Competitions	Ranking points to earn for reaching the following place									
	1st	2nd	3rd	4th	5th	6th	7th	8th	9th	10th
Olympic Games	1300	900	750	750	600	550	500	450	100	100
World Championships	1200	800	650	650	500	450	400	350	100	90
Continental Multi-Sport Games	700	500	350	350	250	200	150	100	50	10
Confederation Championships	500	400	300	300	200	150	100	50	20	0

(\*) The above listed ranking points will be adjusted for the Continental Championships based on the number of Boxers in each Weight Category as follow:

- 7 Boxers or less: 50% deduction from above listed points
- 8 to 11 Boxers: 30% deduction from above listed points
- 12 Boxers or more: No deduction

1.7. For Women, World Ranking points will be allocated for the following listed competitions:

- Olympic Games
- World Championships
- Continental Multi-Sport Games
  - All-Africa Games
  - Asian Games
  - European Games
  - Pan American Games
- Confederation Championships

Ranking Competitions	Ranking points to earn for reaching the following place				
	1st	2nd	3rd	4th	5th
Olympic Games	1300	900	750	750	600
World Championships	1200	800	650	650	500
Continental Multi-Sport Games	700	500	350	350	250
Confederation Championships	<u>500</u>	<u>400</u>	<u>300</u>	<u>300</u>	<u>200</u>

(\*) The above listed ranking points will be adjusted for the Continental Championships based on the number of Boxers in each Weight Category as follow:

- 7 Boxers or less: 50% deduction from above listed points
- 8 to 11 Boxers: 30% deduction from above listed points
- 12 Boxers or more: No deduction

1.8. A disqualified Boxer for a violation of the AIBA Disciplinary Code including for anti-doping issues will not be awarded with any ranking point.

## 2. Extra Criteria (Men and Women)

2.1. Any Boxer who changes Weight Category will be awarded 75% of all points granted in the previous Weight Category.

2.2. Two (2) Boxers with the same amount of points will be FIRSTLY ranked by the number of competitions in which they participated.

2.3. In case two (2) Boxers have the same number of points gained in the same number of competitions, they will be ranked through the best result in the highest ranked competition as follows:

- 2.3.1. World Championships
- 2.3.2. Olympic Games
- 2.3.3. Confederation Championships
- 2.3.4. Youth World Championships



### 3. Result Protocol

3.1. In order to determine each place in a 3-Star Competition, the Boxers result must be classify as follows:

Result	Rank	Competition Stages
1	1	Gold
2	2	Silver
3	3	Loser vs Gold in Semi-Final (SF)
3	4	Loser vs Silver in Semi-Final (SF)
5	5	Loser vs Gold in Quarter-Final (QF)
5	6	Loser vs Silver in Quarter-Final (QF)
5	7	Loser in QF vs Loser to Gold in SF
5	8	Loser in QF vs Loser to Silver in SF
9	9	Loser vs Gold in Round of 16
9	10	Loser vs Silver in Round of 16

3.2. If a Bout cannot take place, at any stage of the competition before the Semi-Finals, the opponent in the next round will win by Walkover. If a Semi-Final Bout cannot take place, the silver medal and one bronze medal will not be awarded. If a Final Bout cannot take place, the gold and silver medal will not be awarded. If both Semi-Finals Bouts cannot take place, no medals will be awarded.

## APPENDIX C – SEEDING PROCEDURE FOR THE OFFICIAL DRAW (Men and Women)

### 1. Seeding Commission

- 1.1. A Seeding Commission must be formed before each relevant competition.
- 1.2. Eligibility
  - 1.2.1. It must be formed by AIBA Supervisors and/or AIBA ITOs.
- 1.3. Number of Members:
  - Three (3) members for Confederation Championships.
  - Five (5) members for all other competitions.
- 1.4. The Seeding Commission will be formed no later than one (1) month prior to each competition by the AIBA President based on the recommendations of the AIBA Technical & Rules Commission.

### 2. Seeding Procedure of the Official Draw

- 2.1. A Seeding System will apply for the following competitions (for both Men and Women unless otherwise stated):
  - 2.1.1. Olympic Games
  - 2.1.2. AIBA World Championships
  - 2.1.3. Continental Multi-Sport Games, taking place after September 2016
  - 2.1.4. Men Elite Confederation Championships
- 2.2. To ensure even strength throughout the Official Draw and to avoid the best World Ranked Boxers meeting in the early rounds, the Official Draw may be seeded or arranged subject to the restrictions for all AOB Competitions (World Championships and Continental Championships) and for the Olympic Games as follows:
  - 2.2.1. No seeds if there are less than 4 entries in the Weight Category (Men and Women)
    - 2.2.1.1. A maximum of two seeds if there are 4 to 15 entries in the Weight Category;
    - 2.2.1.2. A maximum of four seeds if there are more than 15 entries in the Weight Category;
    - 2.2.1.3. A maximum of eight seeds if there are more than 31 entries in the Weight Category;
    - 2.2.1.4. A maximum of sixteen seeds if there are more than 63 entries in the Weight Category;
  - 2.2.2. The AIBA Seeding Commission will review the performances of the WSB Boxers before each World Championships and Olympic Games.
    - 2.2.2.1. At the AIBA World Championships, in each Weight Category except in Heavyweight and Super Heavyweight, 4 additional seeding places to the quota described in above Rule 2.2.1. will be allocated to the highest ranked WSB Boxers of the previous WSB season.

- 2.2.2.2. At the AIBA World Championships, in Heavyweight and Super Heavyweight categories, 2 additional seeding places to the quota described in above Rule 2.2.1. will be allocated to the highest ranked WSB Boxers of the previous WSB season.
- 2.2.2.3. At the Olympic Games, in each Weight Category, 2 additional seeding places to the quota described in above Rule 2.2.1. will be allocated to the highest ranked WSB Boxers of the previous WSB season.
- 2.2.3. Seeding Quota for Host Country:
- 2.2.3.1. Only in the AIBA World Championships will the Host Country receive the 8th ranking seed in each Weight Category if any Boxer from the Host Country is not qualified for any position among 8 allocated seeds by both AIBA and/or WSB World Rankings.
- 2.3. For the Competitions listed in above Rule 2.1., the seeding of the Official Draw will be controlled by AIBA. To accomplish this, all entries must be forwarded by the Organizing Committee to the AIBA Headquarters.
- 2.4. The Official Draw will be conducted as follows:
- 2.4.1. The number of byes must be defined and placed as follows:
- 2.4.1.1. When the number of Boxers is 4, 8, 16, 32, 64, 128 or any higher power of 2, they will meet in pairs in the order drawn, as in Diagram 1, for 8 Boxers.
- 2.4.1.2. When the number of Boxers is not a power of 2, there will be byes in the first round of Bouts. The number of byes will be equal to the difference between the next higher power of 2 and the number of Boxers (e.g. with 17 Boxers, there are  $32 - 17 = 15$  byes).
- 2.4.1.3. Byes will be placed as in Diagram 2.
- 2.4.2. Seeded entries will be selected from the highest AIBA World Ranked Boxers and highest WSB Ranked Boxers in the competition.
- 2.4.3. Seeded entries will be placed as detailed in the example draw in Diagram 2. Seeded entries in the top half of the draw will be placed at the top and bottom of their sections (e.g. eights or sixteenths), and in the bottom half of the draw at the bottom and top of their sections.
- 2.4.3.1. Depending on the number of seeds as listed in Rule 2.2.1., the top 2 and 4 seeded entries will be dealt with as follows and shown in Diagram 2 and Diagram 3 (eg. 1 seed, 2 seed, 3 seed, 4 seed):
- Number 1 placed at the top of the diagram;
  - Number 2 placed at the bottom of the diagram;
  - Number 3 placed at the top half of the bottom of the diagram;
  - Number 4 placed at the bottom half of the top of the diagram.
- 2.4.3.2. The other seeds will be dealt with taking into account the requirements of above rules.
- 2.4.3.3. Numbers 5 to 8 or 9 to 16 will be placed as shown in Diagram 2 and Diagram 3 (eg. 5-8 seed or 9-16 seed) and will be drawn by lot by an independent panel of observers.
- 2.4.3.4. The remaining places will be filled with non-seeded Boxers randomly by the Computerized Draw System.

# Diagram 1

1st Round

2nd Round

Final

Winner

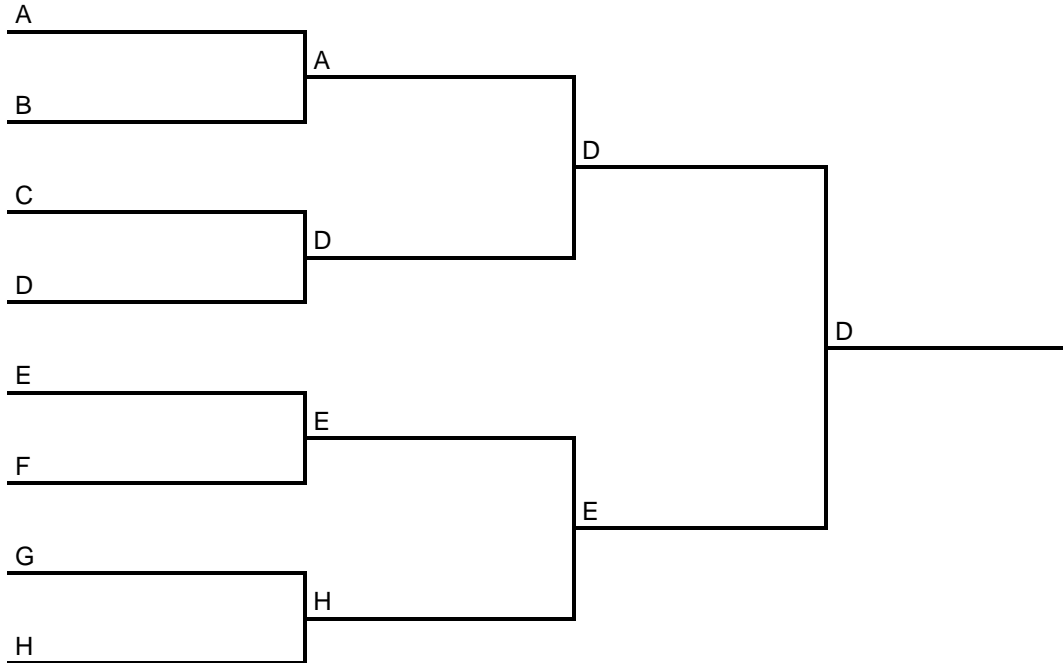

## Diagram 2

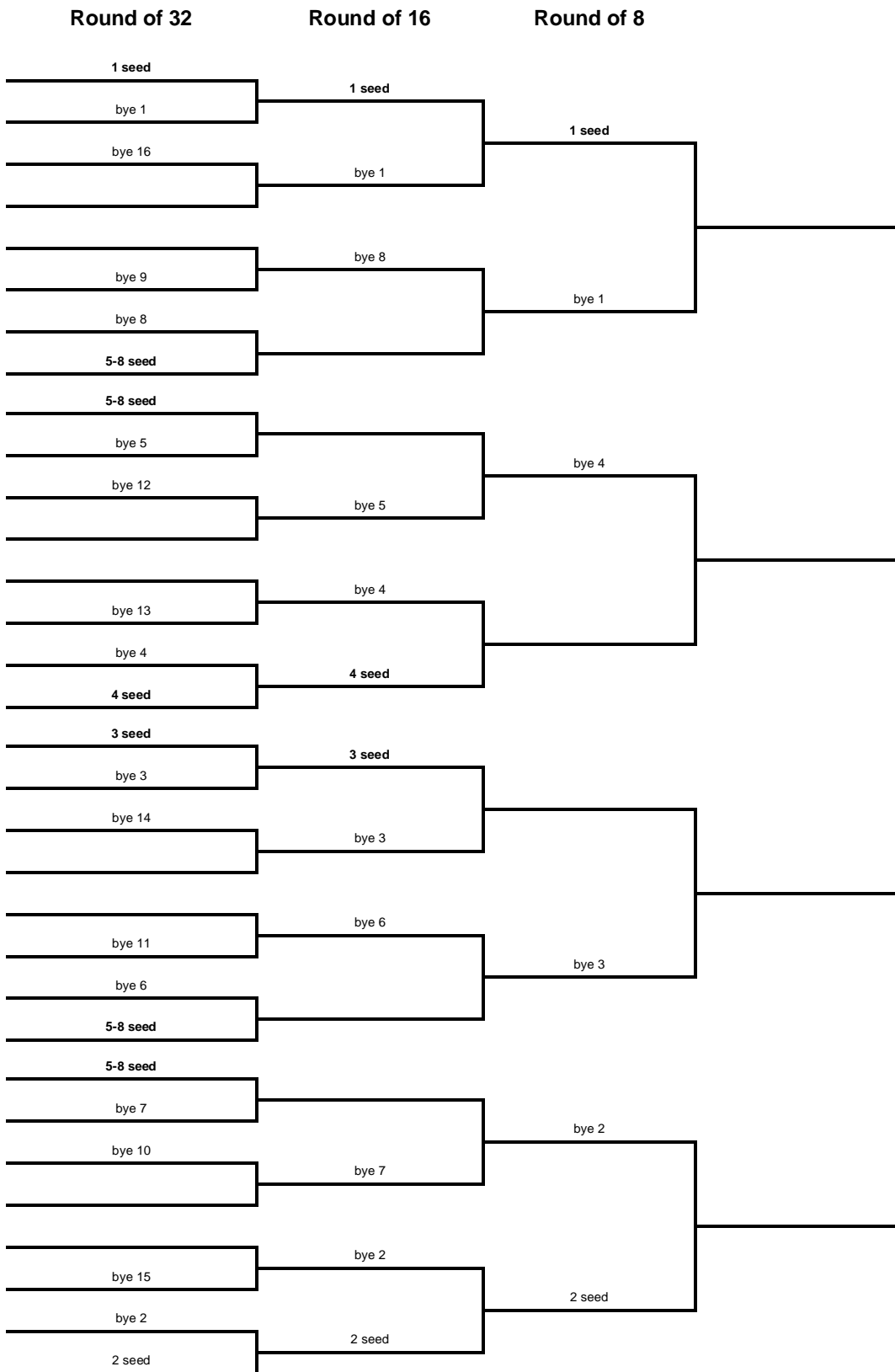

# Diagram 3 (Top Part)



# Diagram 3 (Bottom Part)

Round of 64    Round of 32    Round of 16    Round of 8



## APPENDIX D – BOXERS' UNIFORM GUIDELINES

### 1. Vest and Shorts/Skirt Specifications

#### 1.1. National Flag

- 1.1.1. The flag of the country of the National Federation may be displayed only once on the vest and once on the shorts and/or skirt.
- 1.1.2. The flag must not contain any manufacturer's identification, sponsor advertising, design features or other elements.
- 1.1.3. The flag may be printed, embroidered or sewn on as a badge.
- 1.1.4. There are no restrictions on the shape of the flag, but the following measurements and positioning on the kit item must be observed:
  - 1.1.4.1. Vest: Maximum 50cm<sup>2</sup> (fifty square centimeters) front of the vest, at heart level and side
  - 1.1.4.2. Shorts and/or skirt: Maximum 50cm<sup>2</sup> (fifty square centimeters) front of left leg.

#### 1.2. Manufacturers' Logo

- 1.2.1. The manufacturer's identification may be printed, embroidered or sewn on to the vest and shorts/skirt and must not interfere with the other elements identifying the National Federation (e.g. flag). The following quantities, positioning and measurements must be observed:
  - 1.2.1.1. Vest:
    - The logo identification is permitted to be positioned once on the front of the vest at chest level on the right area
    - Maximum 30cm<sup>2</sup> (thirty square centimeters)
  - 1.2.1.2. Shorts and/or skirt:
    - The logo identification is permitted to be positioned once at the front of right leg
    - Maximum 30cm<sup>2</sup> (thirty square centimeters)

#### 1.3. Olympic National Abbreviation of the National Federation

- 1.3.1. The Olympic National Abbreviation of the National Federation may be displayed only once on the back of the vest.
- 1.3.2. The letters used for the Olympic National Abbreviation of the National Federation must not exceed 10cm (ten centimeters) in height.
- 1.3.3. The letters used for the Olympic National Abbreviation of the National Federation must be in a contrasting color to the color(s) of the vest. For a better legibility, they may be affixed to a neutral colored patch or surrounded by a border or shadow outline.
- 1.3.4. The Olympic National Abbreviation of the National Federation must not interfere with the other elements of the kit identifying the Boxer (e.g. Boxer's name).

#### 1.4. Boxer's Name:

- 1.4.1. Each Boxer may be identified by means of the surname on the back of the vest. The name must be identical to that indicated in the passport.



- 1.4.2. The name must be positioned on the upper part of the back of the vest between the shoulder blades area. The letters used for the name must not exceed 5cm (five centimeters) in height and the name width must not exceed 20cm (twenty centimeters).
  - 1.4.3. The letters used for the name must be in a contrasting color to the color(s) of the vest. For a better legibility, they may be affixed to a neutral colored patch or surrounded by a border or shadow outline.
  - 1.4.4. They may not contain any manufacturer identification, sponsor advertising, design features or other elements.
- 1.5. National Federation's Sponsors Advertising
- 1.5.1. All forms of advertising for sponsors or third parties, of political, religious or personal statements or other prohibited class such as alcohol (exception for beer and wine), tobacco, casino, gambling and betting are prohibited on all kit items inside the Competition Venue.
  - 1.5.2. The National Federation's sponsor advertising may be printed, embroidered or sewn on to the vest and must not interfere with the other elements identifying the National Federation (e.g. the flag). The following quantities, positioning and measurements must be observed:
    - 1.5.2.1. Vest:
      - The sponsor advertising is permitted once to be positioned on the front of the vest below the chest level area
      - Maximum 150cm<sup>2</sup> (one hundred fifty square centimeters).

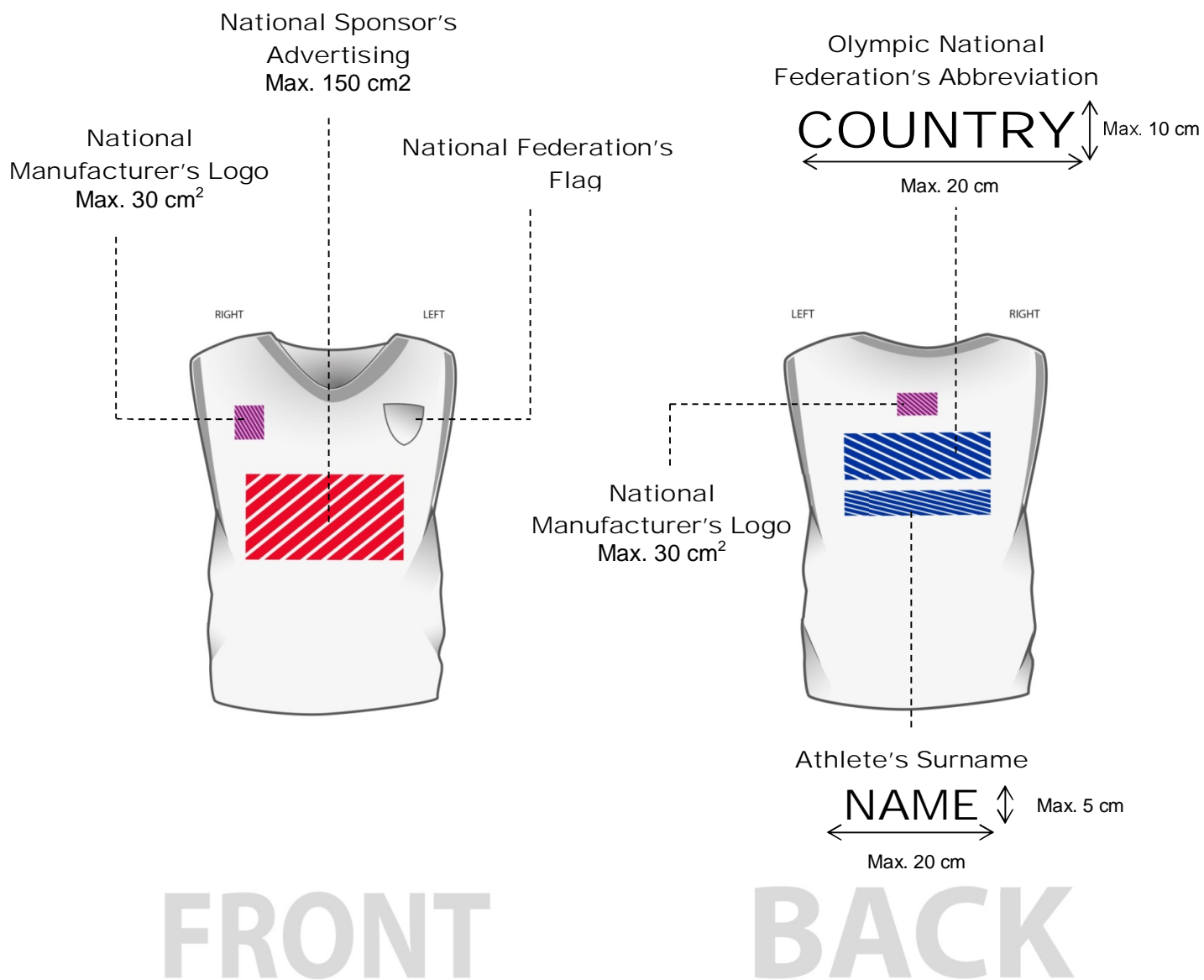

## APPENDIX E – GLOVES AND HEADGUARD SPECIFICATIONS AND GUIDELINES

### 1. Gloves

- 1.1. Gloves must weigh 284 grams (approx. 10 oz) and 340 grams (approx. 12 oz), with a tolerance of 5% up or downwards, of which the leather portion must not weigh more than half of the total weight, and the padding portion not less than half of the total weight. The margin of 5% would also apply downwards and upwards, respectively.
- 1.2. The size of the gloves must respect the measurements as described in the graphic below.
- 1.3. Only gloves with Velcro closing systems will be approved for all AOB Competitions. The glove closure system may be covered by surgical tape with a maximum of one layer around the wrist part of the gloves to avoid any cut or laceration for the opponent.
- 1.4. The leather portion of the gloves must be made of high quality leather such as:
  - 1.4.1. Cowhide leather
  - 1.4.2. Grade A leather
  - 1.4.3. Others of equivalent quality subject to AIBA's approval.
- 1.5. The thumb must be fixed to the main body of the gloves by the top part and with a maximum gap of ten (10) millimeters.
- 1.6. The competition identification may be printed and may be displayed at the following positioning and measurements:
  - 1.6.1. Maximum 50cm<sup>2</sup> (fifty square centimeters) on the front top part of each glove.
- 1.7. The official manufacturer's logo may be printed and may be displayed at the following positioning and measurements:
  - 1.7.1. Maximum 24cm<sup>2</sup> (twenty four square centimeters) on the thumb of each glove.
- 1.8. Any other form of advertising is prohibited such as and non-limited to figurative logo, design mark, script and manufacturer name, etc.
- 1.9. The AIBA label must be placed on the internal part of the gloves.

8-10 cm      20 cm

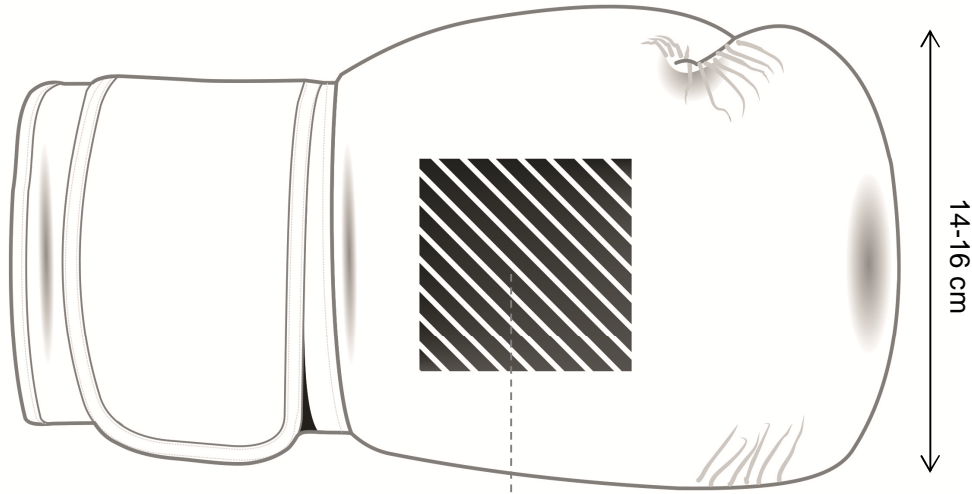

Manufacturer's Logo  
Max. 50 cm<sup>2</sup>

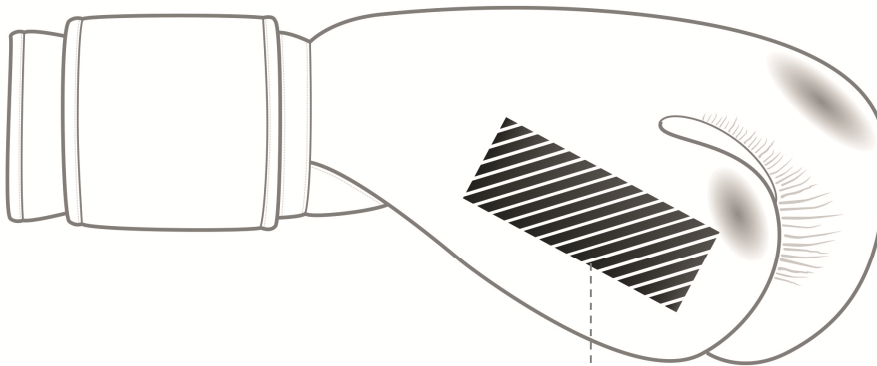
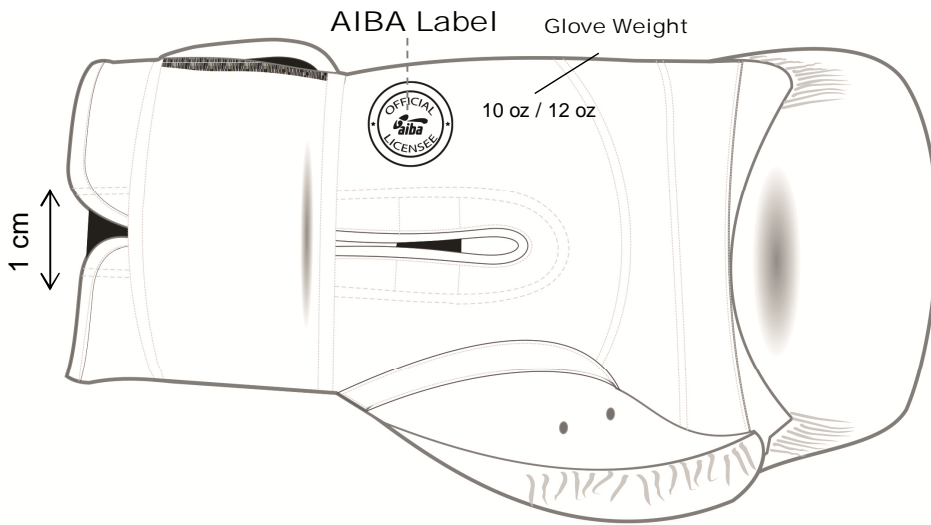

Manufacturer's Logo  
Max. 24 cm<sup>2</sup>  
(Must fit in a 3cm x 8cm rectangle)

## 2. Headguards

- 2.1. Headguards must weigh a maximum of 450 grams (approx. 16 oz).
- 2.2. Headguards will be allowed in the competition in the 4 mandatory sizes (S=Small, M=Medium, L=Large, XL ExtraLarge).
- 2.3. Only headguards with Velcro closing systems will be approved for all AOB Competitions.
- 2.4. The measurements of the headguards must respect the dimension as described in the graphic below.
- 2.5. The padding of the headguards must respect a minimum thickness of two (2) to three (3) centimeters.
- 2.6. The leather portion of the headguards must be made of high quality leather such as:
  - 2.6.1. Cowhide leather
  - 2.6.2. Grade A leather
  - 2.6.3. Others of equivalent quality subject to AIBA's approval.
- 2.7. The official manufacturer's logo may be printed and may be displayed at the following positioning and measurements:
  - 2.7.1. Maximum 50cm<sup>2</sup> (fifty square centimeters) on the front part of the headguards.
- 2.8. The official manufacturer's logo may be printed and may be displayed at the following positioning and measurements:
  - 2.8.1. Maximum 40cm<sup>2</sup> (forty square centimeters) on the back part of the headguards.
- 2.9. Any other form of advertising is prohibited such as and non-limited to figurative logo, design mark, script, manufacturer name, etc.
- 2.10. The AIBA label must be placed on the inside part of the headguards.

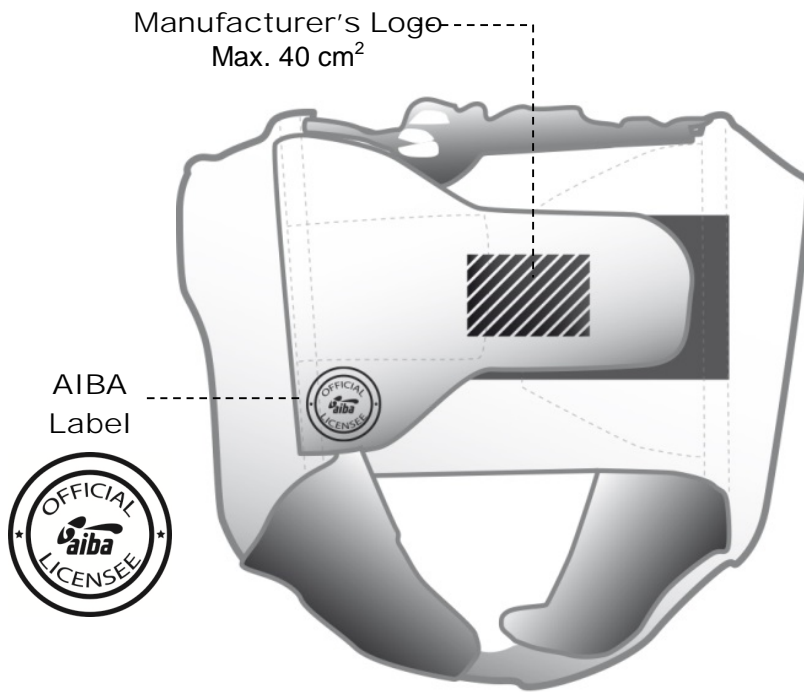
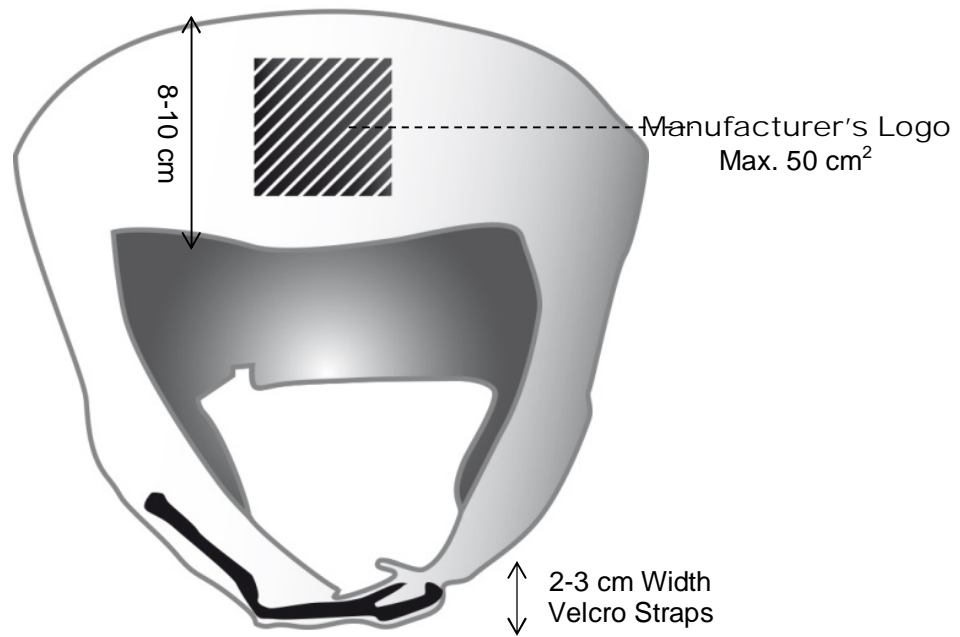

## APPENDIX F – DECLARATION OF NON-PREGNANCY

### 1. Declaration of Non-Pregnancy for Women Boxers aged 18 (eighteen) and Older

Date: \_\_\_\_\_

Place: \_\_\_\_\_

Name of Competition: \_\_\_\_\_

I, \_\_\_\_\_, declare that I am not pregnant.

I understand the seriousness of this statement and accept full responsibility for it. In the case that this declaration is subsequently shown to be inaccurate or untrue and I suffer any related injury or damage during the competition, I on behalf of myself, my heirs, executors and administrators, waive and release any and all claims for damages I may have against AIBA (including its officials and employees), the organizers of the competition (including the Organizing Committee and/or the Host Federation) and the Competition Venue owners for such injury or damage.

Signature of the Boxer

\_\_\_\_\_

## 2. Declaration of Non-Pregnancy for Girls Boxers aged Under 18 (eighteen)

Date: \_\_\_\_\_

Place: \_\_\_\_\_

Name of Competition: \_\_\_\_\_

I, \_\_\_\_\_, one of the parents / legal guardians of \_\_\_\_\_,  
(insert name of the Boxer) and declare, on her behalf, that she is not pregnant.

I understand the seriousness of this statement and accept full responsibility for it. In the case that this declaration is subsequently shown to be inaccurate or untrue and \_\_\_\_\_, (insert name of the Boxer) suffers any related injury or damage during the competition, I on behalf of \_\_\_\_\_, (insert name of the Boxer), her heirs, executors and administrators, waive and release any and all claims for damages she may have against AIBA (including its officials and employees), the organizers of the competition (including the Organizing Committee and the Host Federation) and the Competition Venue owners for such injury or damage.

\_\_\_\_\_  
[Signature of one of the Parents / Legal Guardian]

Acknowledged by

\_\_\_\_\_  
[Signature of the Boxer]



## **APPENDIX G – USER’S GUIDELINES FOR CAVILON™ CUT PREVENTION**

### 1. About Cavilon™

Cavilon™ durable barrier cut prevention is a concentrated cut prevention that:

- protects red and strongly irritated skin by providing a long lasting barrier;
- provides moisture to dry skin;
- allows adhesive products to stick to the skin by increasing the adherence of some adhesive products as medical tapes (such as Steri-strip, adhesive dressing) and/or surgical glue.

### 2. Protocol in Boxing Competitions

#### 2.1. Protocol

- A two grams single dose pack of Cavilon™ will be given to each Boxer's Coach for an IMMEDIATE application with examination gloves on the Boxer's face after the Daily Weigh-In.
- The daily pass for entering the Bout will not be provided if Cavilon™ has not been administered under the control of Officials. The Coach should necessarily wear examination gloves when Cavilon™ is applied on the Boxer's face.

#### 2.2. First Application

- The Boxer's face should be gently and thoroughly cleaned to make it dry (which will increase Cavilon™'s efficiency)
- Cavilon™ should be applied sparingly to cover each exposed area of the Boxer's face such as:
  - (1) Over eyebrows
  - (2) Infra orbital area and malar bone
  - (3) Front and supra orbital area
  - (4) Under eyebrow (but avoiding the inside of the eyes)
  - (5) Nose bridge
  - (6) All the face and scalp
- When all exposed areas are covered, the layer should be made more homogenous by using a finger to cover the entire face until the limit of the scalp.

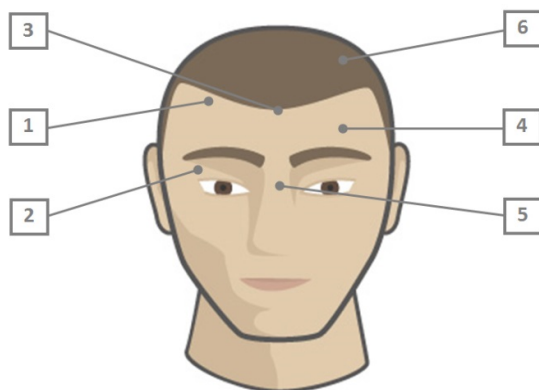

### 2.3. Second Application

- At least half an hour before the beginning of the Bout, the Coach must go to the Equipment Manager to be provided with a single use dose pack of Cavilon™ to be applied as above.
- When this is done, the Equipment Manager will give the Coach the boxing equipment as required.

### 3. DO and DON'T

	DO	DON'T
Before putting Cavilon™	Wear gloves and wipe carefully the skin	Put Cavilon™ directly without gloves and clean the skin
Cavilon™ layer aspect	Carefully wipe and remove the excess of Cavilon™ until the skin is transparent	Let the white color aspect of Cavilon™ over the skin
Drying the skin after putting on Cavilon™	Carefully remove the excess of Cavilon™ and help the skin to dry until it is transparent	Let the brightness appear over the skin